

USER INSTRUCTIONS

WALL HUNG RSF GAS FIRED CONDENSING REGULAR BOILER

GREENSTAR CDi CLASSIC REGULAR ^{ErP}

HEATING SYSTEMS
AND INDIRECTLY FED DOMESTIC HOT WATER



6 720 815 726 (2015/05)

The appliance is for use with:
Natural Gas or L.P.G. (CAT II 2H3P type C13 & C33)

Natural Gas:
30CDi Classic Regular ^{ErP} GC number 41-406-33
40CDi Classic Regular ^{ErP} GC number 41-406-35

L.P.G.:
30CDi Classic Regular ^{ErP} GC number 41-406-34
40CDi Classic Regular ^{ErP} GC number 41-406-36

FOR OPEN VENTED AND SEALED CENTRAL

UK/IE

WORCESTER
Bosch Group

PREFACE

PLEASE READ THESE INSTRUCTIONS CAREFULLY

These instructions are applicable to the Worcester, Bosch Group boiler model stated on the front cover only.

These instructions apply in the UK/IE only and must be followed except for any statutory obligation.

After installation please leave this User instruction Manual, Installation, Commissioning and Servicing Instructions and completed Benchmark Checklist with the user.

DEDICATED TO HEATING COMFORT

Thank you for purchasing a Greenstar gas-fired condensing regular boiler manufactured by Worcester, Bosch Group. The company prides itself on manufacturing boilers to the strictest quality control standards throughout every stage of production.

Worcester, Bosch group has led the field in innovative boiler design and performance for over 50 years. This heritage means all our products are of exceptional quality and proven reliability.

The Greenstar range in particular is extremely energy efficient, offering you economical running costs and value for money. It is amongst the top energy rated appliances available.

There is also the reassurance of our no-nonsense 5 years parts and labour guarantee - backed up by Worcester Total Cover, an optional complete maintenance scheme to keep your boiler operating at peak condition and efficiency.

TABLE OF CONTENTS

1	Key to symbols and safety instructions	3
1.1	Key to symbols	3
1.2	General safety instructions	3
2	Product details	4
2.1	General Information	4
2.2	Product data on energy consumption	4
3	Operating the boiler	5
3.1	Controls	5
3.2	Switching the boiler on/off	6
3.3	Setting the central heating temperature	7
3.3.1	Controlling the central heating	7
3.4	Frost protection (for the boiler)	8
3.4.1	Frost protection (for the heating system)	8
3.5	Fault condition	9
4	Maintenance	10
4.1	Fault finding	10
4.2	Error codes	11
4.3	Extreme cold weather	12
5	General notes	12
6	Fault or Breakdown	13
7	Tips on energy saving	13
8	Environment / disposal	14
9	Your guarantee	14
10	Glossary	15

1 KEY TO SYMBOLS AND SAFETY INSTRUCTIONS

1.1 KEY TO SYMBOLS

WARNINGS



Warnings in this document are identified by a warning triangle printed against a grey background.

Keywords at the start of a warning indicate the type and seriousness of the ensuing risk if measures to prevent the risk are not taken.

The following keywords are defined and can be used in this document:

- **NOTE** indicates a situation that could result in damage to property or equipment.
- **CAUTION** indicates a situation that could result in minor to medium injury.
- **WARNING** indicates a situation that could result in severe injury or death.
- **DANGER** indicates a situation that will result in severe injury or death.

IMPORTANT INFORMATION



This symbol indicates important information where there is no risk to people or property.

ADDITIONAL SYMBOLS

Symbol	Explanation
▶	Step in an action sequence
→	Cross-reference to another part of the document
•	List entry
–	List entry (second level)

Table 1

1.2 GENERAL SAFETY INSTRUCTIONS

These installation instructions are intended for gas fitters, plumbers, heating engineers and electricians.

- ▶ Read any installation instructions (boiler, heating controls, etc.) carefully before starting the installation.
- ▶ Observe the safety instructions and warnings.
- ▶ Observe national and regional regulations, technical rules and guidelines.
- ▶ Record all work carried out.

IF YOU SMELL GAS

A gas leak could potentially cause an explosion. If you smell gas, observe the following rules.

- ▶ Prevent flames or sparks:
 - Do not smoke, use a lighter or strike matches.
 - Do not operate any electrical switches or unplug any equipment.
 - Do not use the telephone or ring doorbells.
- ▶ Turn off the gas at the meter.
- ▶ Open windows and doors.
- ▶ Warn your neighbours and leave the building.
- ▶ Prevent anyone from entering the building.
- ▶ Well away from the building: call the National Gas Emergency Service on 0800 111 999.

INTENDED USE

This boiler must only be used as a heat appliance in a sealed hot water heating system for domestic purposes.

Any other use is considered inappropriate. Any damage that results from such use is excluded from liability.

INSTALLATION, COMMISSIONING AND SERVICING

Installation, commissioning and servicing must only be carried out by a competent, Gas Safe registered engineer.

- ▶ Carry out a gas tightness test after completing work on gas-carrying components.
- ▶ Only use original spares.

ELECTRICAL WORK

Electrical work must only be carried out by a qualified electrician.

- ▶ Before starting electrical work:
 - Isolate the mains electrical supply and secure against unintentional reconnection.
 - Check for zero potential.
- ▶ Also observe connection diagrams of other system components.

HANDOVER TO THE USER

When handing over, instruct the user how to operate the heating system and inform him about its operating conditions.

- ▶ Explain how to operate the heating system and draw the user's attention to any safety-relevant action.
- ▶ Explain that modifications and repairs must only be carried out by an authorised contractor.
- ▶ Advise the user to have the system serviced annually by a competent, Gas Safe registered engineer.
- ▶ Leave the installation instructions with the completed Benchmark Checklist (or a certificate confirming compliance with IS 813, Eire only) and the operating instructions with the user or at the gas meter.

servicing of the boiler/heating system and this can become a valuable document when, for example, you wish to sell the property. The log book will show a potential purchaser that the heating system has received regular professional maintenance and servicing during its lifetime.

The Benchmark initiative aims to:

- Raise standards among professional installers
- Build and maintain high safety standards in the industry
- Improve customer satisfaction levels
- Make a contribution to the nation's commitment to climate change

2.2 PRODUCT DATA ON ENERGY CONSUMPTION

The product data on energy consumption (ErP) can be found in the installation and maintenance instructions for contractors.

2 PRODUCT DETAILS

2.1 GENERAL INFORMATION

SERVICING



Ensure that the service engineer completes the Service Record in the Benchmark Checklist after each service. The Benchmark Checklist and service interval record can be found at the rear of the Installation, Commissioning and Servicing Instructions.

- The boiler must be serviced regularly by a competent, qualified person, such as a Worcester service engineer or other Gas Safe registered engineer.
- Always use original spares, to help maintain the efficiency, safety and reliability of the boiler and have the Service Record completed in the Benchmark Checklist.

The completed Benchmark Checklist will be required in the event of any guarantee work and may be required by the local Building Control Inspector.

BENCHMARK STANDARD



The Benchmark initiative is a code of practice to encourage the correct installation, commissioning and servicing of domestic central heating boilers

and system equipment.

A "checklist" is dispatched with every boiler. This is a vital document that needs to be completed by the installer at the time of installation. It confirms that the boiler has been installed and commissioned according to the manufacturer's instructions.

The log book provides space for the recording of regular

3 OPERATING THE BOILER

3.1 CONTROLS

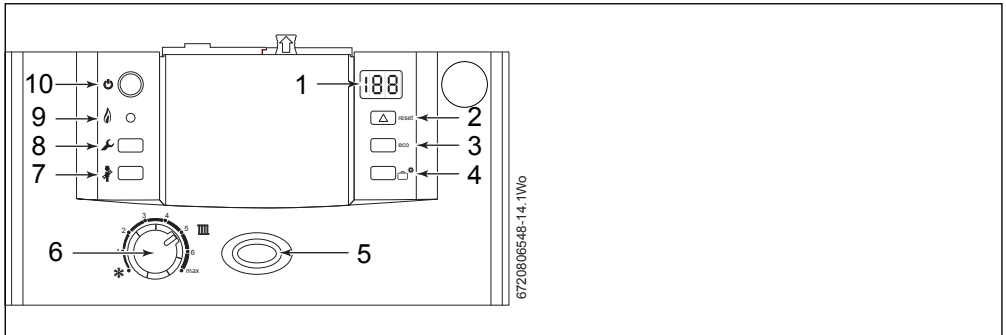

Fig. 1 Control panel

- [1] Display
- [2] Reset button
- [3] Not used
- [4] Not used
- [5] ON/OFF and fault indicator (blue)
- [6] Central heating temperature control
- [7] Performance test button
- [8] Service button
- [9] Burner indicator (green)
- [10] ON/OFF button

3.2 SWITCHING THE BOILER ON/OFF

Switching on

- Switch on the boiler by pressing the ON/OFF button [10].
The ON/OFF indicator [5] shows blue.

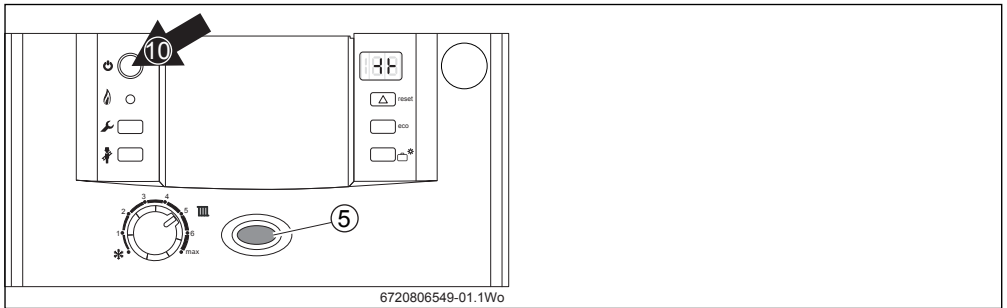

Fig. 2



The boiler runs for 15 minutes at minimum heating output to fill the condensate trap. The display alternates between ---|--- and the central heating flow temperature. This occurs every time the mains supply has been interrupted.

Switching off

- Switch off the boiler by pressing the ON/OFF button.
The ON/OFF indicator light goes out.

3.3 SETTING THE CENTRAL HEATING TEMPERATURE

- ▶ Turn the central heating temperature control [6] to the desired level, between approximately 35°C and 90°C.
- ▶ When the burner is lit, the burner indicator [9] underneath the ON/OFF button shows green.

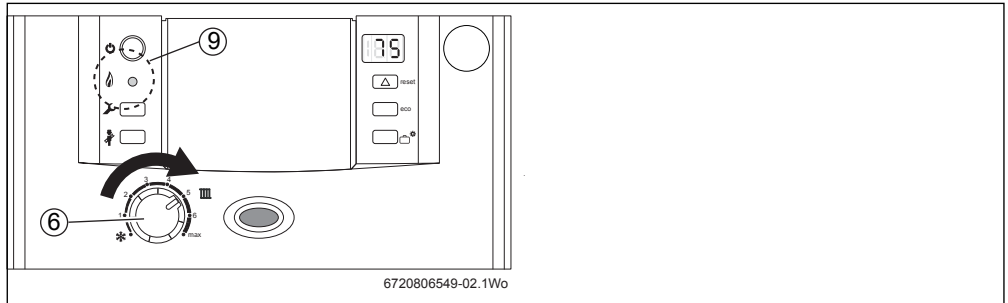

Fig. 3

Position	Central heating temperature
1	approx. 35°C
2	approx. 43°C
3	approx. 50°C
4	approx. 60°C
5	approx. 67°C
6	approx. 75°C
max	approx. 90°C

Table 2 Settings for the central heating temperature

3.3.1 CONTROLLING THE CENTRAL HEATING

Central heating systems must be controlled effectively using a programmer or timer and a room thermostat.

- ▶ For further information on how to control your central heating system please refer to the individual user guides for the programmer or timer installed in your home.

3.4 FROST PROTECTION (FOR THE BOILER)

Activating frost protection will turn off the boiler and prevent heating of the central heating.

If the temperature within the boiler drops to 5°C the boiler will fire to avoid the possibility of freezing.

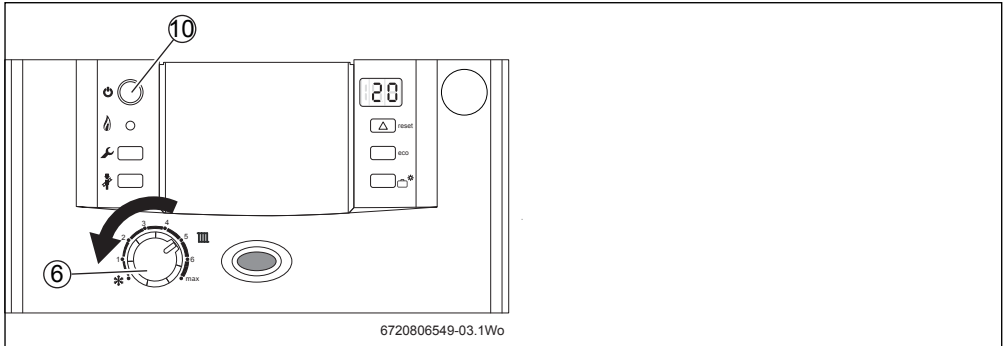



Fig. 4

To activate frost protection:

- ▶ Leave power [10] switch on.
- ▶ Turn the central heating temperature control [6] to .

3.4.1 FROST PROTECTION (FOR THE HEATING SYSTEM)

If remote pipework is likely to be subject to freezing conditions:

- ▶ Ensure the installer has fitted a frost thermostat in the area to protect the pipework from freezing.
- ▶ Ensure the installer has added a suitable anti-freeze fluid to the water in the central heating system.

3.5 FAULT CONDITION

In the event of a fault occurring while the boiler is in operation the reset button and the main fault indicator [5] will flash. The display [1] will show an error code (for error codes see table 4 on page 11)

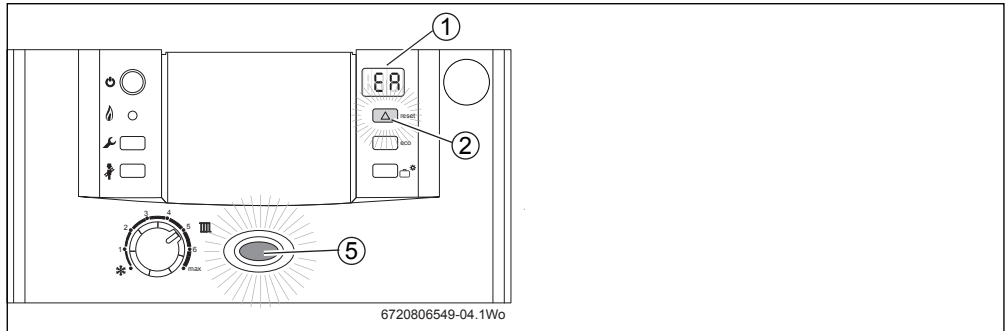

Fig. 5

To reset the boiler:

- ▶ Press the reset button [2] for three seconds. The reset button [2] and the ON/OFF indicator [5] will stop flashing. The boiler will function normally, dependent on programmer and room thermostat settings.



If the fault cannot be cleared by pressing the reset button:

- ▶ Refer to the fault finding section on page 10 of these user instructions.
- ▶ Call Worcester, Bosch Group, giving a description of the fault and, if possible, the fault code from the seven segment display. Alternatively contact other Gas Safe registered personnel for assistance.

4 MAINTENANCE

Your new Greenstar CDi Classic Regular ^{ErP} gas-fired appliance represents a long term investment in a reliable, high quality product.

In order to realise its maximum working life, and to ensure it continues to operate at peak efficiency and performance, it is essential that your boiler receives regular servicing and maintenance checks from a competent person beyond the initial 2 year guarantee period.

If you would like to know more about a Worcester Bosch service contract, please tick the appropriate box on your warranty registration card.

If your Greenstar CDi Classic Regular ^{ErP} should fail to operate correctly or requires servicing please contact the Worcester Bosch Service Department (see back page cover for details).

Details of the boiler including the Gas Council number can be found under the controls cover flap on the boiler.

4.1 FAULT FINDING

This table gives information on basic operating system

problems.

Problem	Cause	Remedy
EA fault code flashing on display	No gas supply/low gas supply pressure	▶ Contact your gas supplier.
	Condensate outlet blocked	▶ If it is safe to do so, check your condensate pipe outlet for blockages, such as ice or foreign objects.
	Flue blocked	▶ If it is safe to do so, check your flue outlet for damage or blockages.
Desired room temperature is not reached	Thermostatic radiator valve(s) set too low	▶ Increase thermostatic radiator valve setting(s)
	Temperature control for central heating flow on boiler set too low	▶ Increase central heating flow temperature control setting
	Air trapped in heating system	▶ Bleed radiators and recharge heating system
	Low temperature setting on the boiler controls	▶ Increase settings on boiler controls
Desired room temperature too high	Radiators are too hot	▶ Turn down thermostatic radiator valves/room thermostat ▶ Reduce central heating temperature by turning down the Central Heating control on boiler
Heating stays on too long	Clock is incorrectly set	▶ Check setting and adjust
ON/OFF Indicator is not illuminated	Momentary power failure	▶ Disconnect boiler supply, wait a few seconds then reconnect.

Table 3 Fault finding

4.2 ERROR CODES



When calling Worcester, Bosch Group, you may be asked for the error code. This Table is for you to help identify the possible cause of the fault.

- ▶ Do not try to rectify any of the faults listed below by yourself.
- ▶ Contact British Gas or a competent, qualified engineer (Gas Safe registered personnel).

Error code	Description
b1	b1 Code plug not detected.
C6	C6 Fan speed too low.
E9	E9 Safety temp. limiter in CH flow has tripped.
EA	EA Flame not detected. If it safe to do so, check for: <ul style="list-style-type: none"> • gas is on in the house • frozen condensate pipe • blocked flue outlet
F0	F0 Internal error.
F7	F7 Flame detected even though boiler switched off.
FA	FA Flame detected after gas shut off.
Fd	Fd Reset button pressed by mistake.

Table 4 Error codes

4.3 EXTREME COLD WEATHER

In some instances where the condensate pipe work is run externally or in an unheated area, such as a garage, the condensate pipe work can be at risk of freezing, even if well insulated.

A frozen/blocked condensate pipe will cause the boiler to shut down.



WARNING: Falling hazard!

Failure to follow this guidance may result in personal injury.

- ▶ Only attempt to thaw a condensate pipe that is at ground level, and that is easily accessible.
- ▶ Never attempt to thaw a condensate pipe that is at height.



CAUTION: Pipe damage

- ▶ **DO NOT** use boiling water to thaw the condensate pipe!

If the condensate pipe has frozen:

- ▶ Locate the blockage.
It is likely that the pipe is frozen at the most exposed point outside the building or where there is an obstruction to flow.
This could be the open end of the pipe, at a bend or elbow, or where there is a sag in the pipe in which condensate can collect.
The location of the blockage should be identified as closely as possible before taking further action.
- ▶ Thaw the frozen pipe.
The pipe can be thawed by applying a hot water bottle, a microwaveable heating pack (the sort used for muscular aches and pains) or a cloth soaked in hot water to the exterior of the pipe, close to the point of blockage.
Hot water, but not boiling, can also be poured onto the pipe from a watering can or similar container.
- ▶ Once the pipe has been thawed the boiler must be reset, press the reset button for five seconds and wait two to three minutes for the boiler to restart.
- ▶ If the boiler does not restart, contact Worcester, Bosch Group Appointments Team on: 0330 123 9559.
- ▶ Contact your installer in order to find a permanent solution to the problem.

5 GENERAL NOTES

PLUMBING AND CONDENSATE DRAIN

This is a condensing boiler and the flue terminal will, at times give out a plume of water vapour. This is quite normal.

The boiler also produces quantities of condensate which is discharged regularly via a pipe to drain. This pipe must not be blocked or altered in any way.

PUMP ANTI-SEIZURE

If there has been no heating demand for 24 hours the boiler will run the system pump for a few seconds to reduce the possibility of pump seizure during long periods of inactivity. This is usually more frequent during the summer months.

CLEARANCES

Your installer will have provided adequate space around the boiler for safety and servicing access.

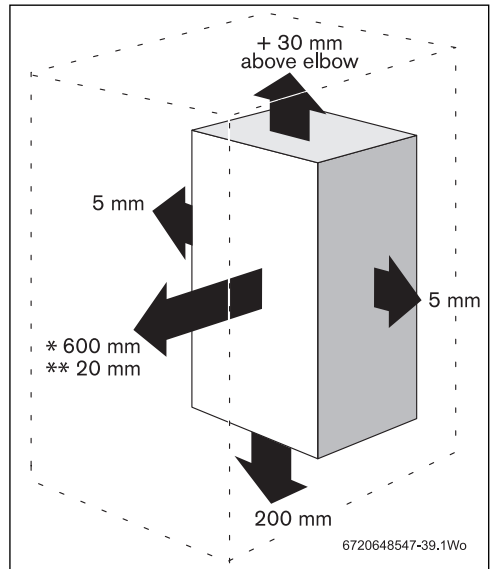

Fig. 6

- * 600 mm service clearance required to a fixed surface
- ** 20 mm from removable door or panel
- ▶ Do not restrict this space with the addition of cupboards, shelves etc. around or next to the boiler.

VENTILATION

This is a room sealed boiler and does not require any air for combustion from inside the property. If a compartment is built around the boiler after installation, then this must be carried out as described in the Installation Manual.



CAUTION: Risk of damage to the boiler.

- ▶ Do not operate the boiler if the flue terminal is obstructed or damaged in any way.

6 FAULT OR BREAKDOWN

This boiler is supported in the UK and Eire by Worcester, Bosch Group.

Specialist Service Engineers are available to attend a breakdown occurring on this boiler.



Invoices for attendance and repair work carried out on this boiler by any third party will not be accepted.

- No charge will be made for parts and/or labour providing: A boiler fault is found and the boiler is within the guarantee period. Reasonable evidence of this must be supplied on request. i.e. the Benchmark Checklist.
- A call-out charge will be made where:
 - The boiler is outside the guarantee period.
 - Evidence cannot be provided that the first year service inspection has been carried out (i.e. an entry in the Benchmark Checklist).
 - Our Field Service Engineer finds no fault with the boiler.
 - The cause of breakdown is misuse or with other parts of your plumbing/heating system, or with equipment not supplied by Worcester, Bosch Group.

TECHNICAL SUPPORT



No boiler fault is found on over 30% of all service calls.

In the case of a suspected fault, refer to the fault finding section of this guide.

In the event of a boiler fault or breakdown please contact Worcester, Bosch Group appointments team on 0330 123 9559.

Your advisor will arrange for an engineer to call with the minimum of delay; under normal circumstances this will be from 1 - 3 working days (excluding weekends and bank holidays) for priority breakdown situations (no hot water and/or heating).

7 TIPS ON ENERGY SAVING

HEATING ECONOMICALLY

The boiler is designed to provide a level of comfort while keeping gas consumption and the resulting environmental effect as low as possible. The gas supply to the burner is controlled according to the level of demand for heat. The boiler continues to operate with a low flame if the demand of heat reduces. The technical term for this is modulating control. Modulating control reduces temperature fluctuations and provides even distribution of heat throughout the home. This means that the boiler may stay on for relatively long periods but will use less gas than a boiler that continually switches on and off.

NEW CONTROL SYSTEMS

Upgrade your heating control system if necessary with the latest equipment available. The minimum level of control is a programmer, interlocking room thermostat and thermostatic radiator valves.

CENTRAL HEATING SYSTEMS WITH ROOM THERMOSTATS AND THERMOSTATIC RADIATOR VALVES

The central heating control on the boiler should be set to maximum rated temperature of the central heating system. The temperature of each room can be set individually (except room with the room thermostat) using the thermostatic radiator valves. If damaged, replace the plastic tops used to adjust the thermostatic radiator valve. It is also advisable to manually adjust all thermostatic radiator valves every 2-3 weeks to prevent them sticking.

ROOM THERMOSTATS

Reducing the setting of the room thermostat by 1 °C can reduce fuel consumption by up to 10 %.

ROOF INSULATION

Around 30 % of the heat loss from a property is through the roof. Replace any old insulation with new insulation, preferably of around 200 mm thickness or more.

WINDOW FRAMES

Single glazed windows, particularly those with steel frames, can lose a great deal of heat. Consideration should be given to replacement with PVCu or wooden framed double glazing units.

CURTAINS

Lined curtains, or heavier full length curtains can provide excellent insulation. However, always ensure that the curtains do not drape over radiators.

DRAUGHTS

To ensure that draughts around doors, windows, letterboxes and keyholes etc. are reduced by using a suitable draught excluder.

RADIATORS

Often radiators are sited underneath a window. The performance of the radiator will be affected if curtains are

allowed to drape over radiator or shelves are fitted above it.

The temperature obtainable in any given room is dependent on all radiators being operated at the same time. If you decide to turn off radiators in unused rooms, spare bedrooms etc., you may experience slightly lower room temperatures in rooms adjacent to unheated rooms.

8 ENVIRONMENT / DISPOSAL

Environmental protection is a fundamental corporate strategy of the Bosch Group.

The quality of our products, their economy and environmental safety are all of equal importance to us and all environmental protection legislation and regulations are strictly observed. We use the best possible technology and materials for protecting the environment taking account of economic

considerations.

PACKAGING

We participate in the recycling programmes of the countries in which our products are sold to ensure optimum recycling. All of our packaging materials are environmentally compatible and can be recycled.



USED APPLIANCES

- ▶ All Greenstar gas boilers are 100% re-cycleable.

The various assemblies can be easily dismantled and synthetic materials are marked accordingly. Assemblies can therefore be sorted by composition and passed on for recycling.

9 YOUR GUARANTEE

This boiler has a guarantee against faulty materials or workmanship for a period of two years from the date of installation subject to the following terms and conditions:

- During the period of this guarantee any components of the boiler which are proven to be faulty or defective in manufacture will be exchanged or repaired free of charge by Bosch Thermotechnology Ltd.
- The householder may be asked to prove the date of installation, that the boiler was correctly commissioned and, where appropriate, the first year's service has been carried out to the satisfaction of Bosch Thermotechnology Ltd., when requested. These should be documented as a part of the Benchmark Checklist.
- The boiler has been used only for the normal domestic purposes for which it was designed.

This guarantee does not affect your statutory rights.

GUARANTEE REGISTRATION

Your Greenstar boiler carries a two year guarantee against faulty material or manufacture subject to Terms and Conditions.

To read the full Terms & Conditions please visit us on-line at www.worcester-bosch.co.uk/guarantee. The Guarantee Registration form is available on this same page and can be completed and submitted electronically.

Alternatively please telephone one of our Guarantee Registration advisors on 0330 123 9559.

Your statutory rights are not affected by the manufacturers guarantee.

FOR YOUR OWN RECORD:

Please ensure that the Benchmark Checklist has been completed by your installer or service engineer.

Model	
Serial No. ¹⁾	
Type/size	
Date of installation	
Name of Installer	
Telephone number of Installer	

Table 5

- 1) See boiler identification label on boiler fascia or Benchmark Checklist in the back of the Installation, Commissioning & Servicing Instructions.

10 GLOSSARY

Central heating systems

All radiators must be heated at an even rate. If the top of a radiator is at a lower temperature than the bottom then it should be bled by releasing air through the bleed screw at the top of the radiator.

Ask your installer to show you how this is done.

This boiler is fitted to a sealed system. Should water leaks be found or if excessive bleeding is required, then a service engineer must be contacted to inspect the installation and rectify any fault.

Only additives that are compatible with aluminium may be used in the system. Any incompatible additive used will invalidate the guarantee.

Plumbing and Condensate drain

This is a condensing boiler and the flue terminal will, at times give out a plume of water vapour. This is quite normal.

The boiler produces condensate which is discharged regularly by a syphon within the boiler via a plastic pipe to a drain. This pipe must not be blocked or altered in any way.

Room thermostat / programmer

A room thermostat / programmer must be fitted to control the central heating. This controls the times and temperatures of the central heating, preventing the boiler from firing unnecessarily. Refer to the instructions supplied with the thermostat and programmer for further information.

Thermostatic radiator valves

Thermostatic radiator valves must be fitted in sleeping accommodation. It is recommended that this type of valve is fitted to all but one of the radiators. The remaining radiator, where the room thermostat is located, must be uncontrolled and left open.

Pump over run function

After the boiler has finished a demand for central heating or hot water, the pump may continue to run for a short while to dissipate the heat from within the boiler.

Pump anti-seizure

If there has been no heating demand for 24 hours the boiler will run the system pump for a few seconds to reduce the possibility of pump seizure during long periods of inactivity.

SEDBUK

Seasonal Efficiency of Domestic Boilers in the UK.

Worcester, Bosch Group
Cotswold Way, Warndon, Worcester WR4 9SW.
Tel. 0330 123 9559
Worcester, Bosch Group is a brand name of
Bosch Thermotechnology Ltd.

worcester-bosch.co.uk

6 720 815 726

WORCESTER, BOSCH GROUP:

TECHNICAL SUPPORT:	0330 123 3366
APPOINTMENTS:	0330 123 9339
SPARES:	0330 123 9779
LITERATURE:	0330 123 9119
TRAINING:	0330 123 0166
SALES:	0330 123 9669



WORCESTER
Bosch Group